

toobalink®

SAVE THE TUBES!™

Hooray for your new Toobalink® Starter Kit! This kit includes everything you need to get building right away, but remember to start saving paper towel and toilet tissue tubes so that you can build bigger and better things. Collect and connect!™

COLLECT
CONNECT

INCLUDED IN THIS KIT:

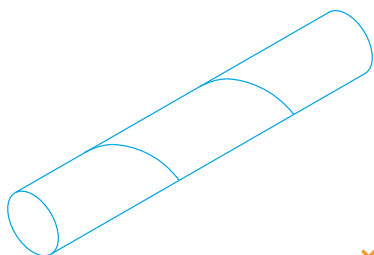

x3



x4

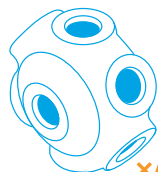

x4

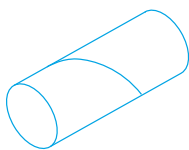

x6

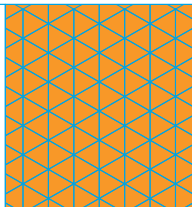

x6



x4

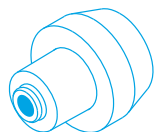

x12

BEFORE YOU GET STARTED:

Before you can build with Toobalink®, you need to assemble the tube connector pieces. Hold a straight connector piece A, and slide an orange foam piece B over the connector as shown. The assembled connector piece is shown in C. Do this for all twelve connector pieces.

A

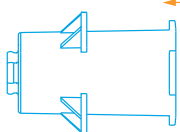

B



C

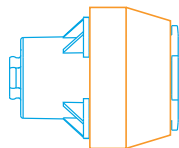

TOOBALINK BASICS

HOW TO USE

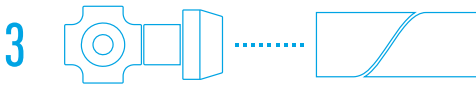
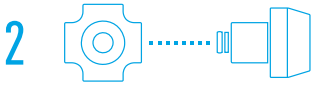

HOW TO USE

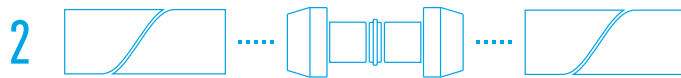

HOW TO USE

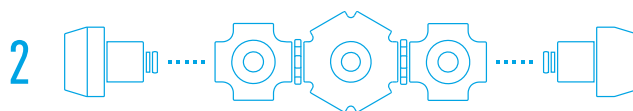
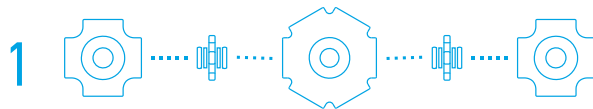

USE TOOBALINK PARTS IN ANY COMBINATION YOU CAN IMAGINE!

LET'S GET BUILDING!

HOW TO BUILD A SWORD:

Parts needed:  x1  x4  x1  x1

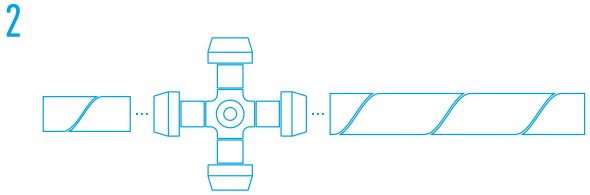
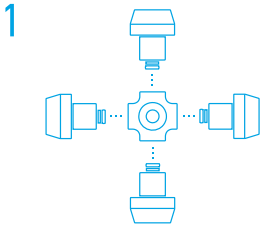

HOW TO BUILD A PET DOG:

Parts needed:  x2  x10  x6  x1

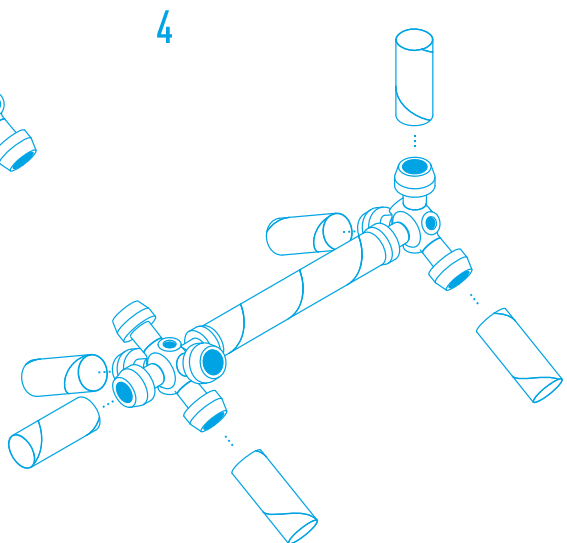
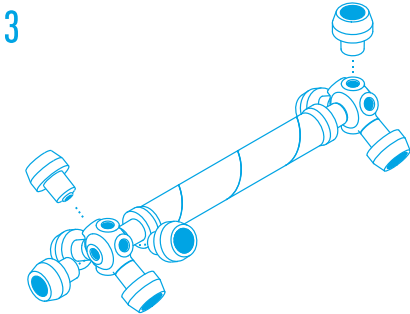
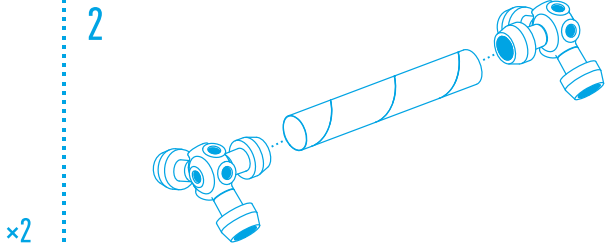
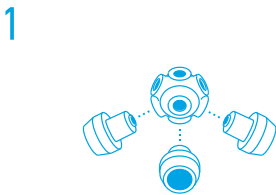

TIP:

Use your markers to give your pet dog some spots!

HOW TO BUILD A TEPEE FRAME:

Parts needed:  ×6  ×1  ×9  ×3

TIP: Save up extra tubes for this project. Collect and connect!

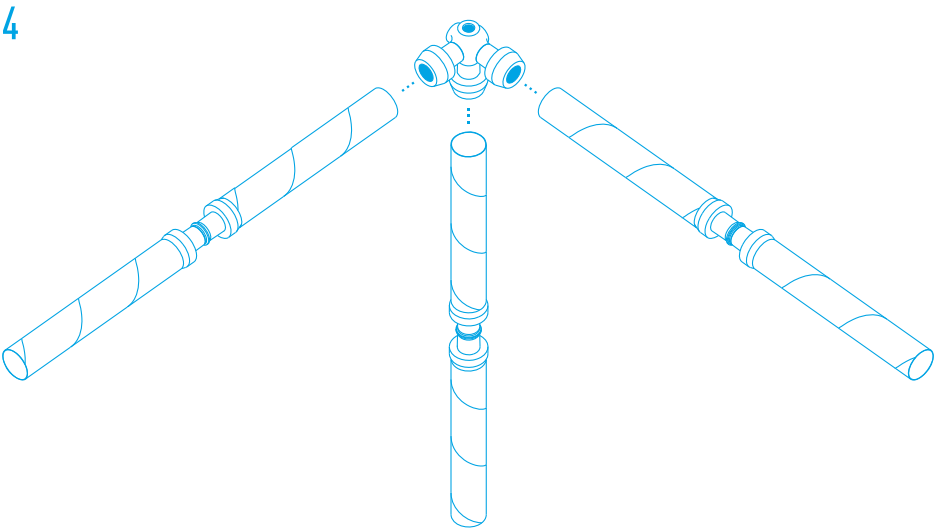
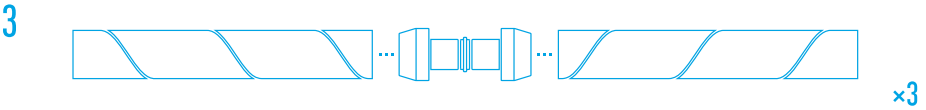
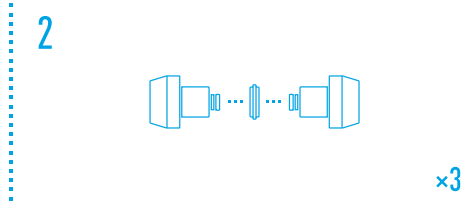
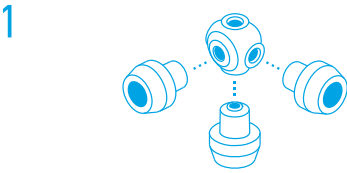

TIP: Toss a small, light bed sheet over the top of your construction and your tepee is complete!

COLLECT MORE TUBES! COLLECT THEM FROM HOME! ASK THE NEIGHBORS! ASK FRIENDS! SAVE THE TUBES!

Share your constructions on Facebook. Post photos at facebook.com/toobalink
For more information visit www.toobalink.com
Comments and questions: info@toobalink.com
Retain for future use

This product has been tested by an independent, third party laboratory, and meets or exceeds the ASTM 963 toy safety standard.

Toobalink[®] is a registered trademark of Metre Ideas and Design, LLC. Patent Pending.

